

Standup Computer Desk Bauhaus Style

Tom Riley
05/09/2006
StandupBauhaus.SKf

<http://woodwaredesigns.com/rsi/standup.html>

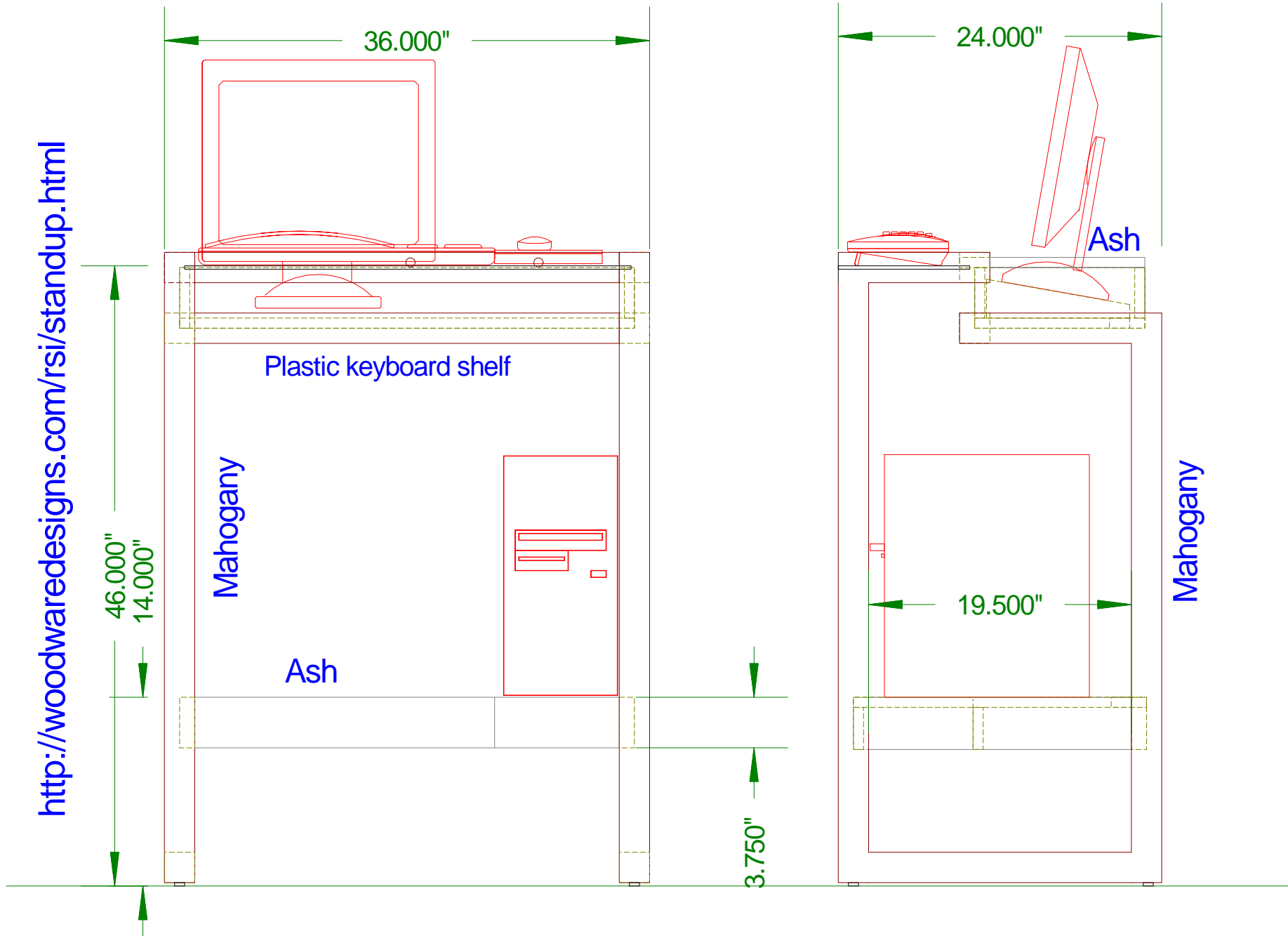

Standup Computer Desk Bauhaus Style Mahogany Rail, Front Sketch #4

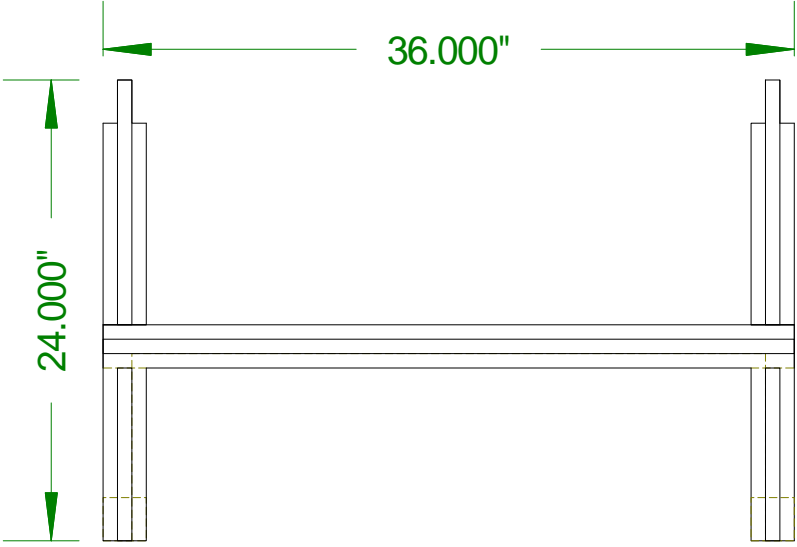

36.000"

24.000"

Dado for shelf

Lapped joints.

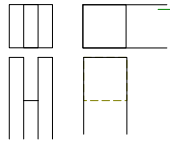

11.250"

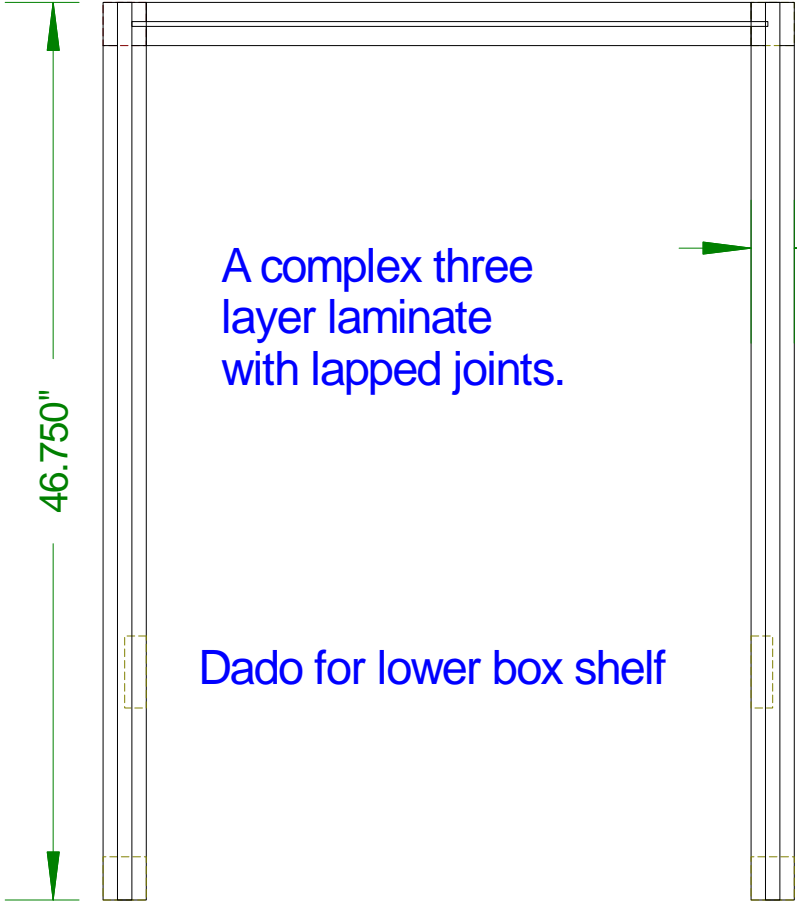
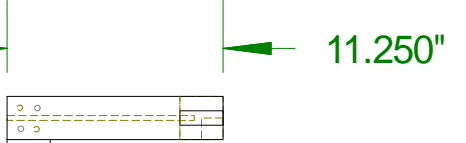

46.750"

A complex three layer laminate with lapped joints.

Dado for lower box shelf

2.250"

2.250"

Last joints, not glued



Standup Computer Desk Bauhaus Style Mahogany Rail, Rear Sketch #5

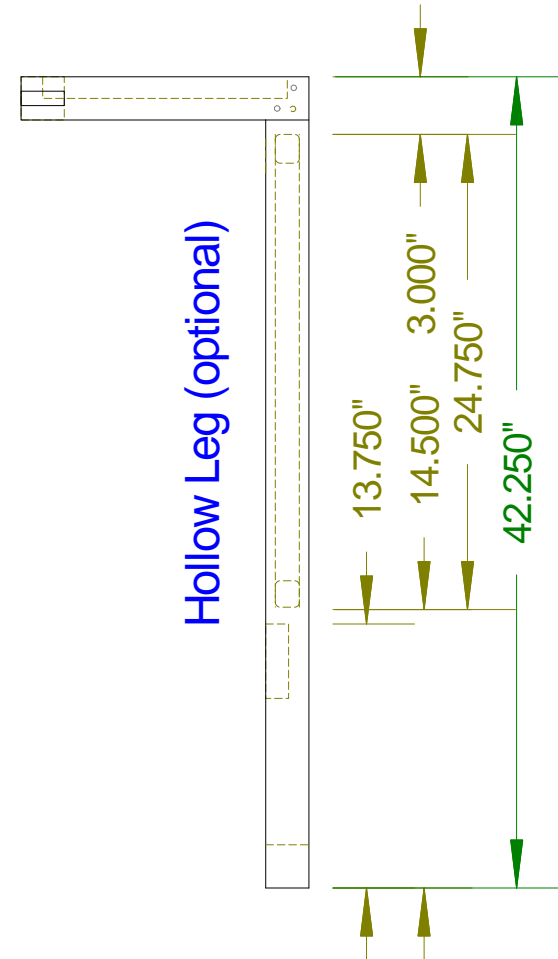
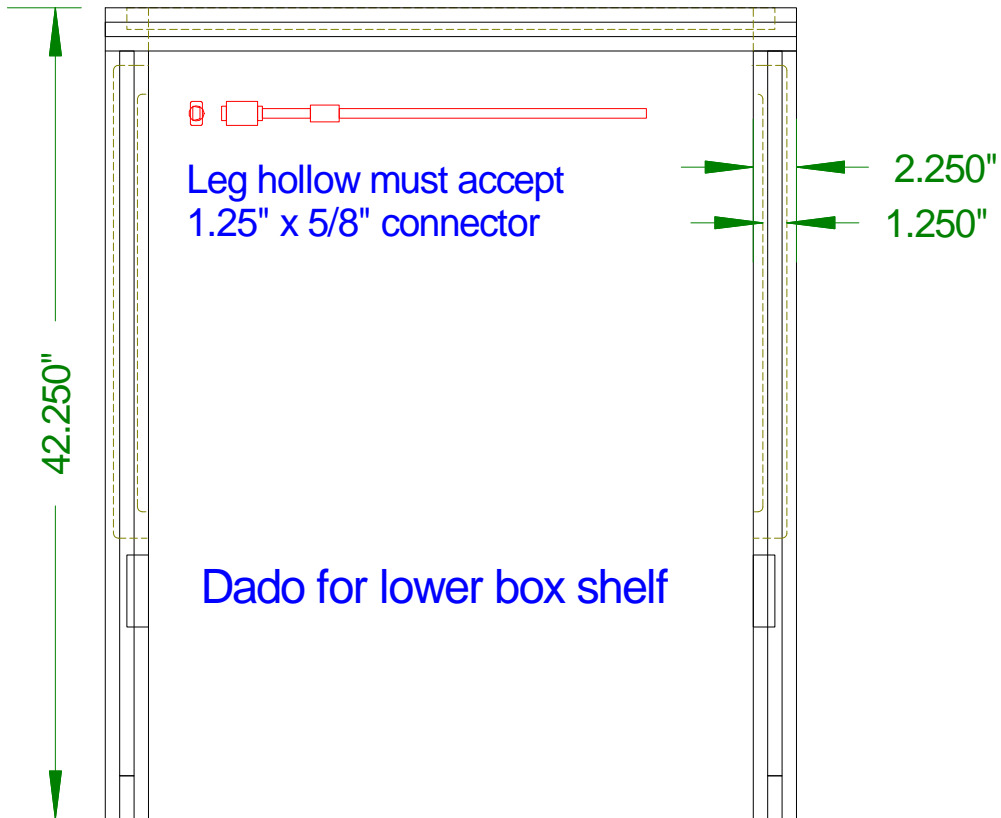
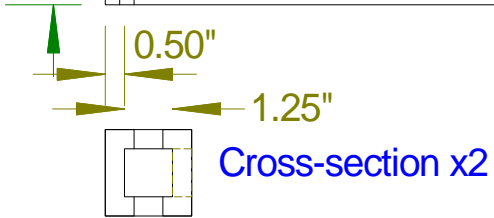
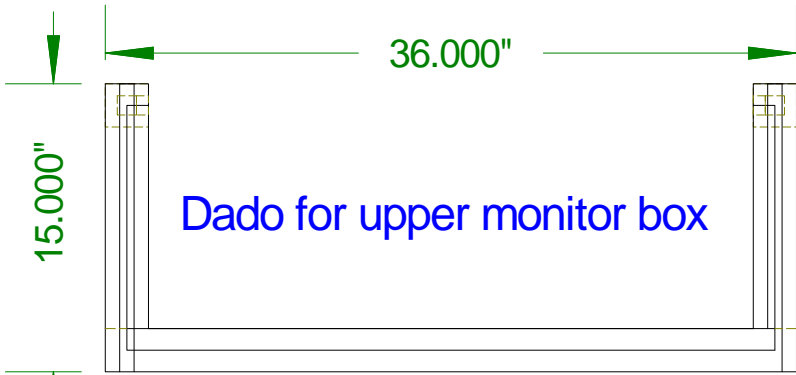

Standup Computer Desk Bauhaus Style

Top View Sketch #2

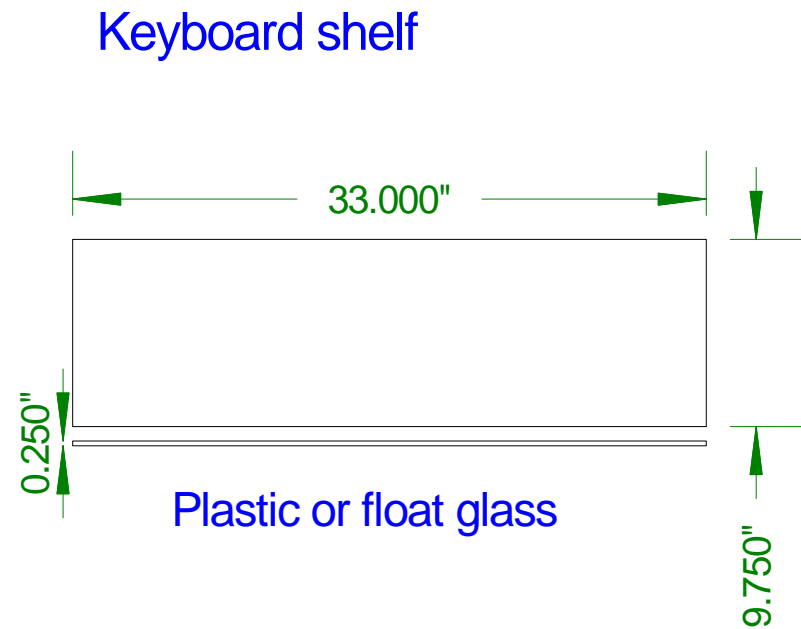
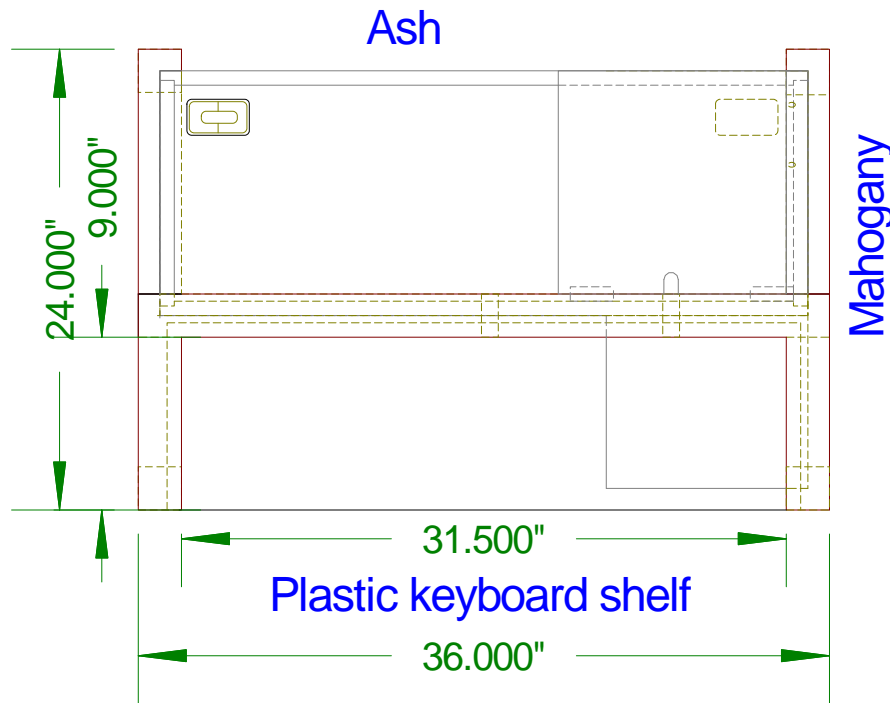

Standup Computer Desk

Bauhaus Style

Isometric View

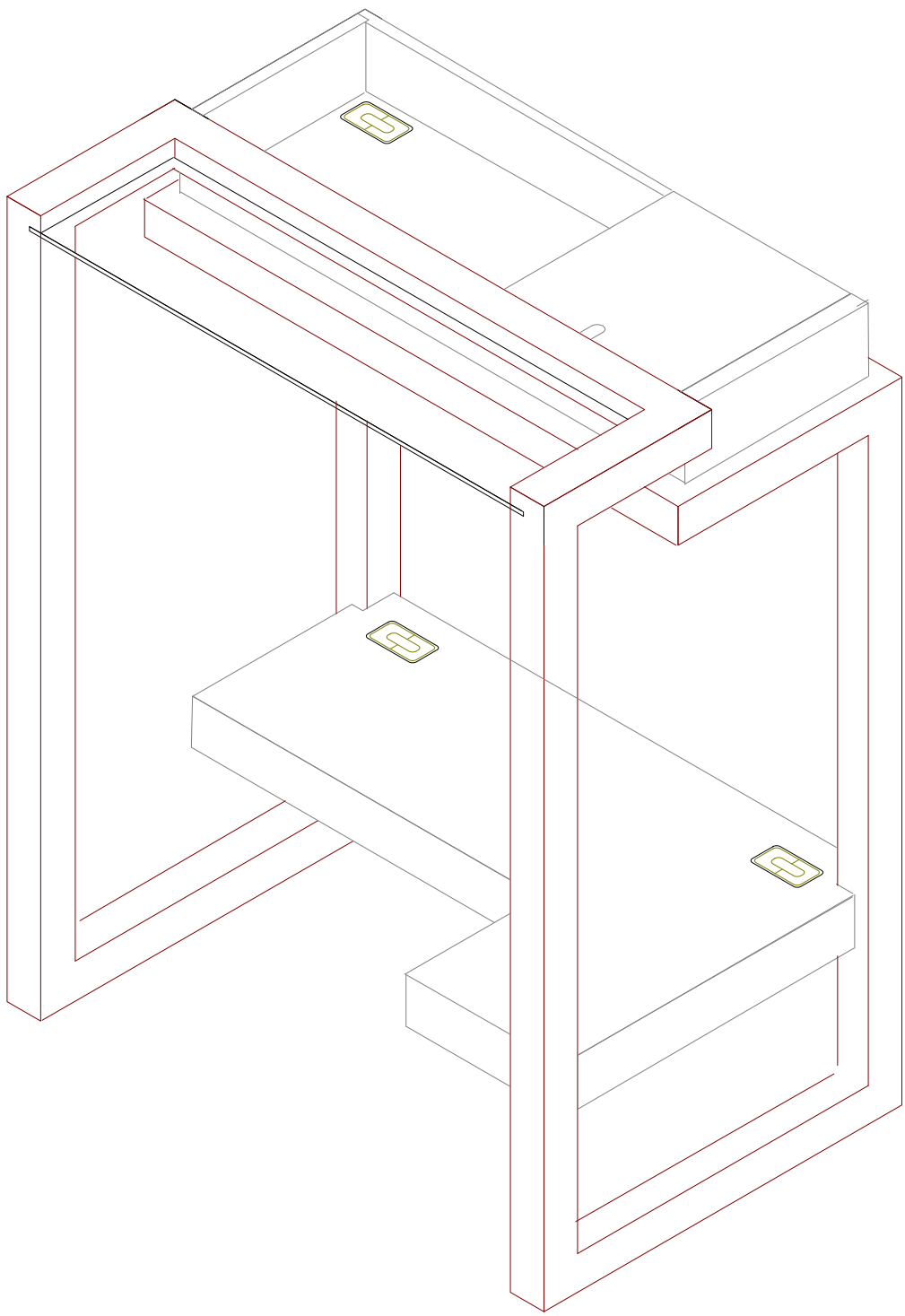

Standup Computer Desk

Bauhaus Style

Mahogany Rail Pieces
Sketch #5

20 bft

Front Legs

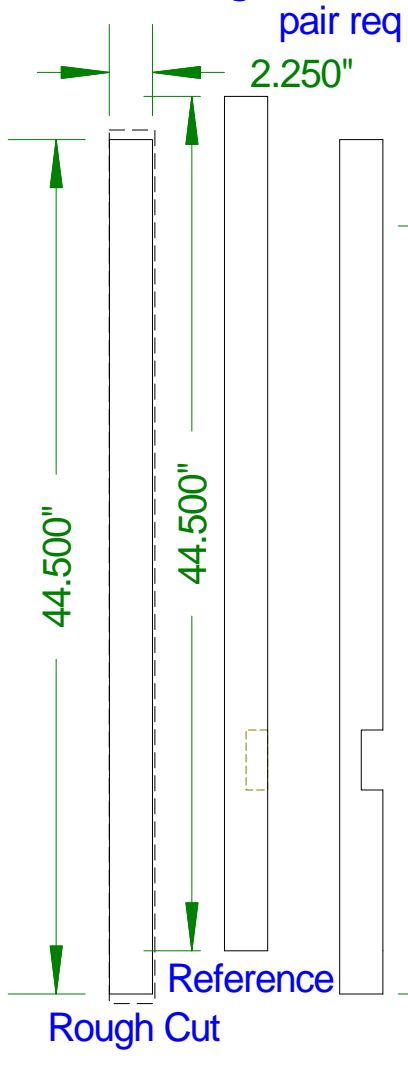

Back Legs

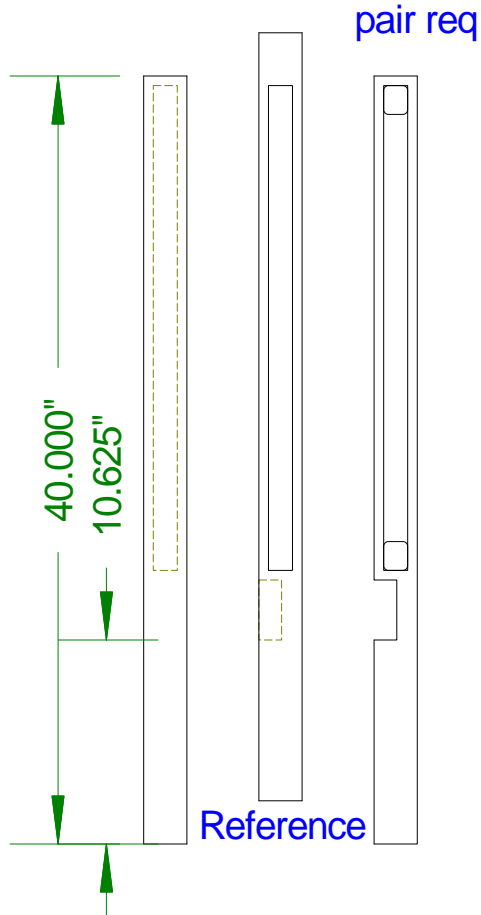

Monitor box cross piece

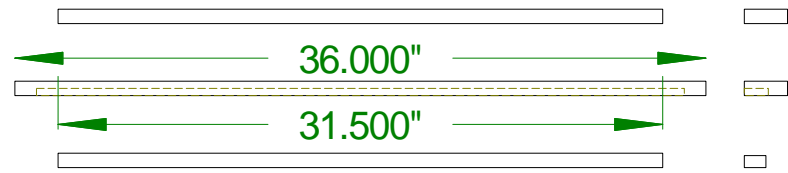

Keyboard cross piece

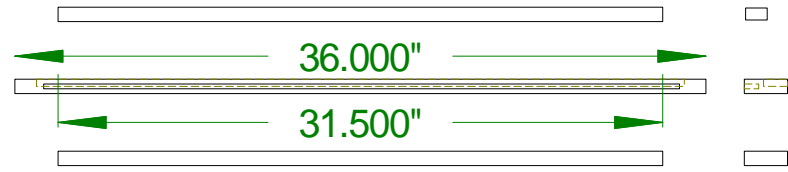

Keyboard shelf support

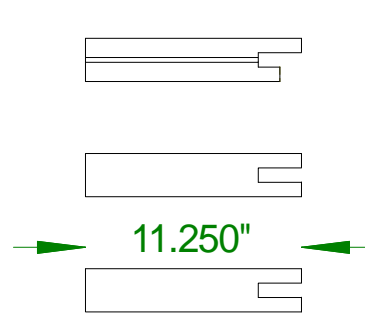

Monitor box support

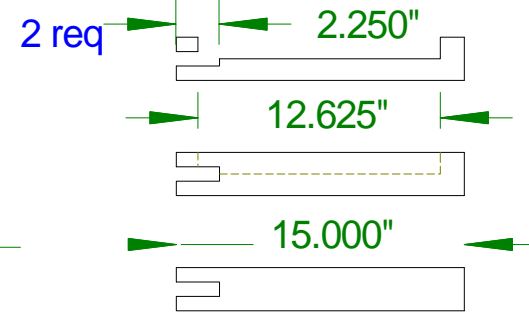

Clamp aid

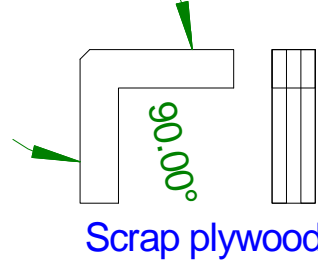

Lower Side

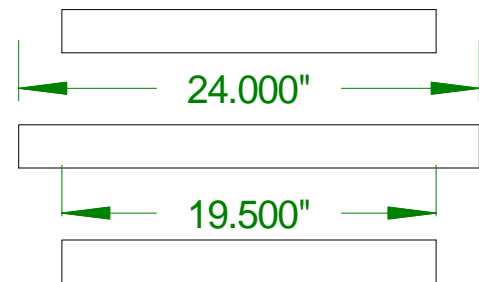

Monitor Box Sketch #6

Standup Computer Desk Bauhaus Style

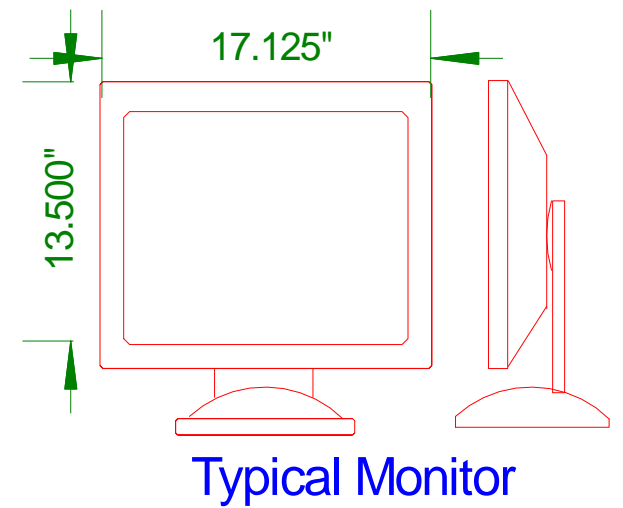
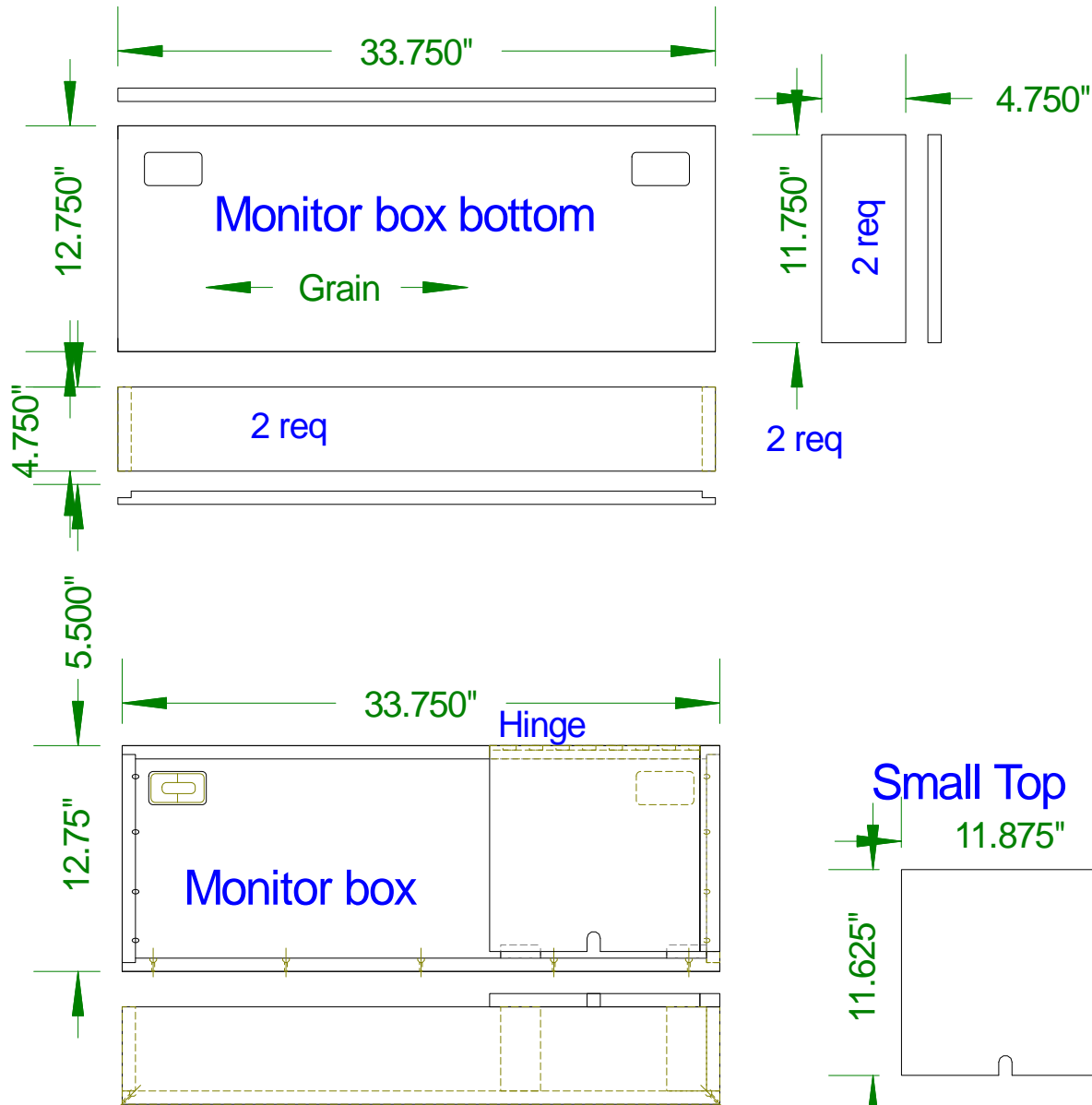

Monitor tilt bridge

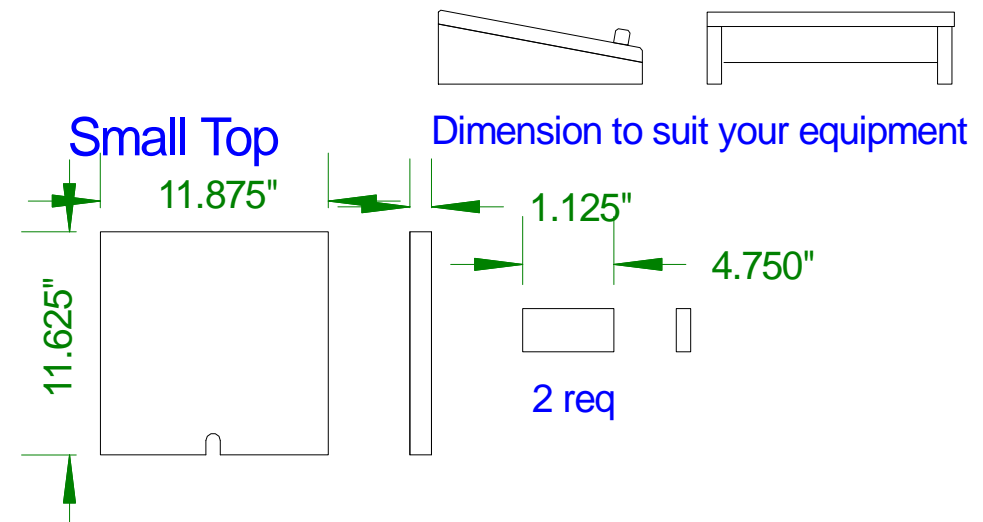

Standup Computer Desk Bauhaus Style

Lower shelf

Computer Shelf Sketch #7

